

75x75x30mm

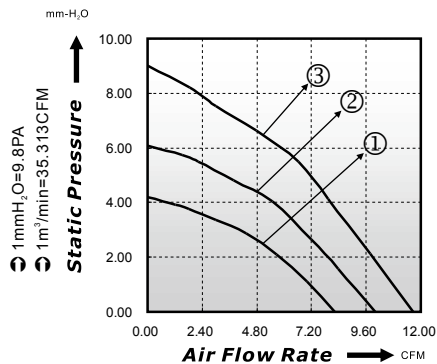

■ P-Q Curve (At Rated Voltage)



■ Dimensions Drawing

Unit: (mm)

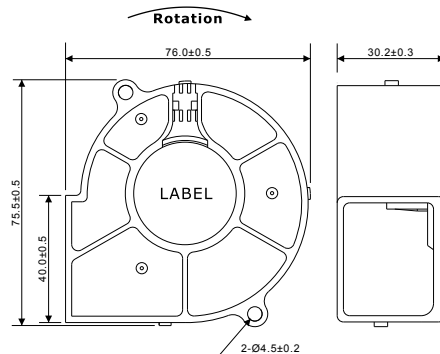

Model No	Bearing (*)	Rated Voltage (VDC)	Rated Current (A)	Power Consumption (Watts)	Speed (rpm)	Air Flow (CFM)	Static Pressure (mmH ₂ O)	Noise (dBA)	Curve
EBD07530-12L*	○ ● ⊖	12	0.10	1.20	2500	8.22	4.20	32.8	1
EBD07530-12M*	○ ● ⊖	12	0.18	2.16	3000	9.99	6.07	36.8	2
EBD07530-12H*	○ ● ⊖	12	0.20	2.40	3500	11.65	9.02	41.0	3
EBD07530-24L*	○ ● ⊖	24	0.08	1.92	2500	8.22	4.20	32.8	1
EBD07530-24M*	○ ● ⊖	24	0.12	2.88	3000	9.99	6.07	36.8	2
EBD07530-24H*	○ ● ⊖	24	0.22	5.28	3500	11.65	9.02	41.0	3

* Bearing Type: ○ Sleeve ● Two Ball ⊖ Hydro-Dynamic